

# 邯郸市主导产业和营商环境

推介人：高和平





人间五月天

浅夏胜春烟







向参加今天活动的各位嘉宾，表示热烈的欢迎！对大家长期以来对邯郸的关心和支持，表示衷心的感谢！





# 邯鄲

- 位于河北最南部
- 西依巍巍太行
- 东接华北平原
- 与晋、鲁、豫三省接壤
- 总面积1.2万平方公里
- 人口1060万

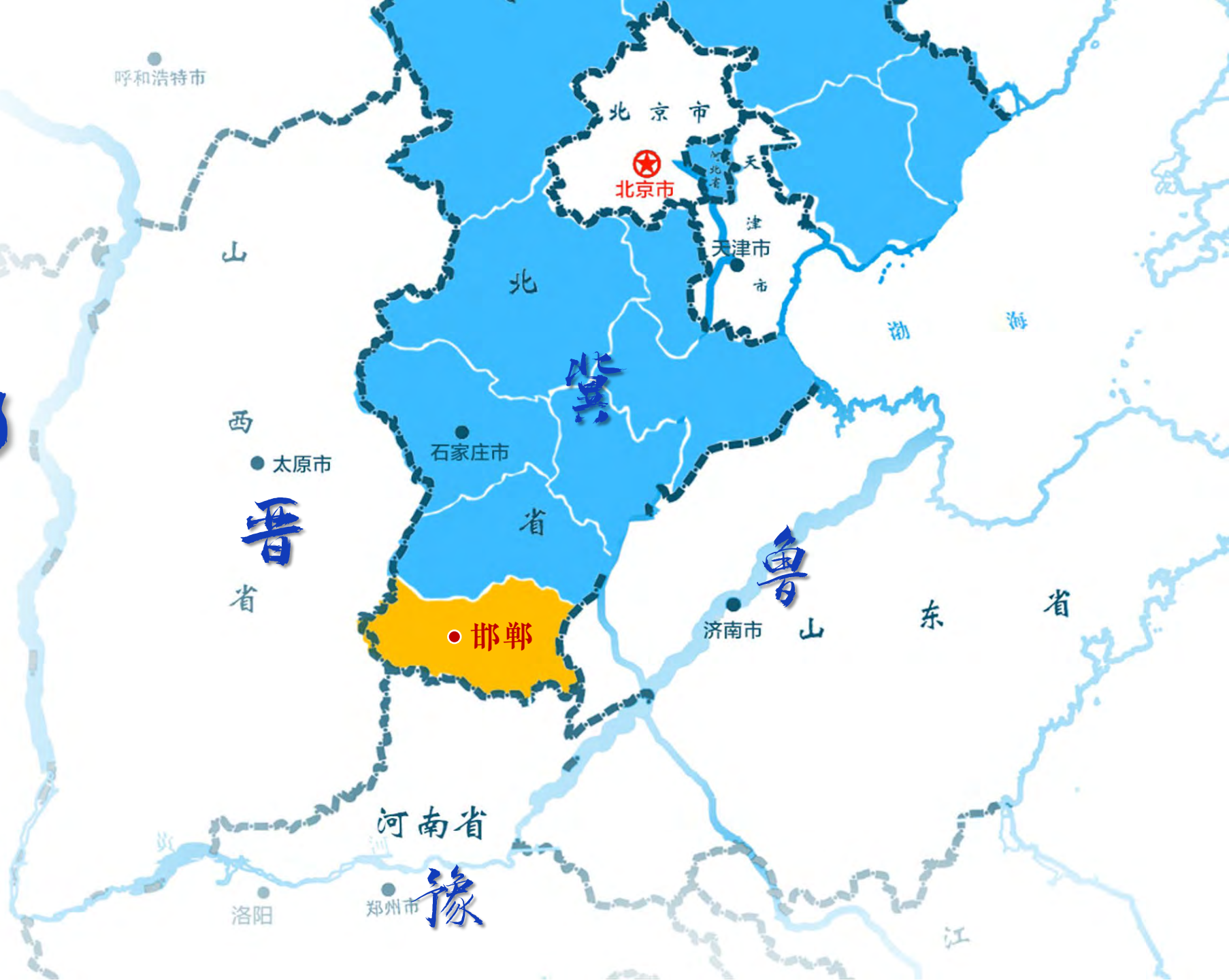



国家园林城市  
中国优秀旅游城市  
全国文明城市  
国家历史文化名城







京津冀协同发展



中原经济区

《京津冀协同发展规划纲要》《中原经济区规划》  
两大国家战略规划都把邯郸定位为“区域性中心城市”



4114.8亿元

全市生产总值

547.8亿元

全部财政收入





邯鄲

历史悠久、文化灿烂





# 8000多年的文明史 3100多年的建城史

是世界上粟（谷子）和黍的最早发源地，也是中国家鸡和中原核桃的最早发现地





邯  
鄲

作为一个城市独属的名称，3100多年来从未改变





战国时期，作为赵国都城达158年  
是秦始皇的出生地和成长地





出自邯郸或与邯郸有关的成语典故达1584条  
被誉为“中国成语典故之都”



完璧归赵



负荆请罪



毛遂自荐



胡服骑射



享有太极拳圣地 的美誉

杨氏太极拳、武氏太极拳的发源地





女娲文化

磁山文化

赵文化

曹魏建安文化

磁州窑文化

太极文化

内涵博大精深

成语典故文化

边区革命文化

风格丰富多彩



成语典故文化



赵文化



磁州窑文化



曹魏建安文化



太极文化



边区革命文化



邯鄲

区位优势、交通便捷





是东出西联、通南达北的重要节点  
地处晋鲁豫冀四省交界

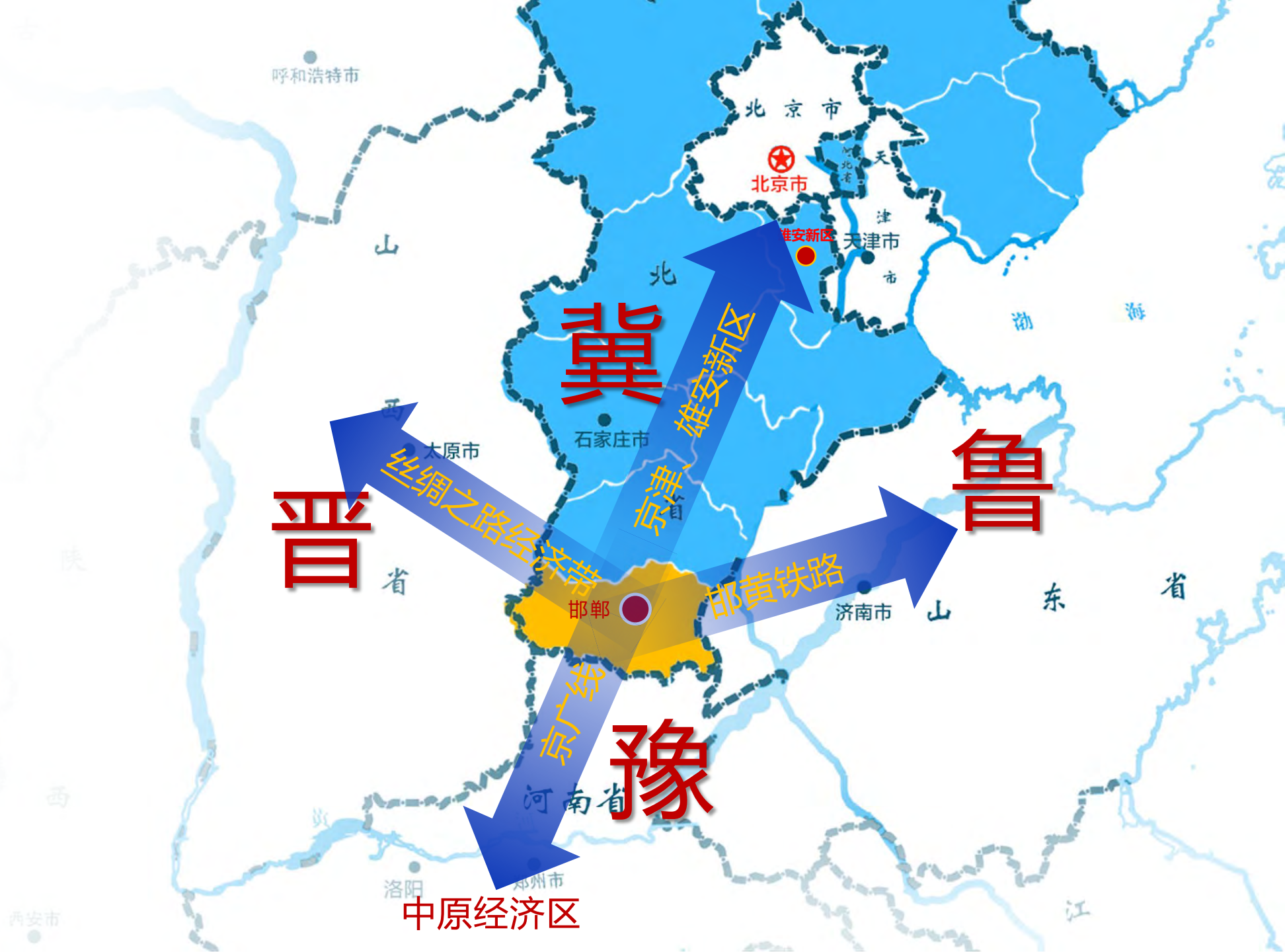





机场通航  
高速纵横  
国道交汇  
铁路交叉

综合立体交通优势明显







# 邯郸机场

- 上海
- 杭州
- 广州
- 深圳
- 厦门
- 成都
- 沈阳

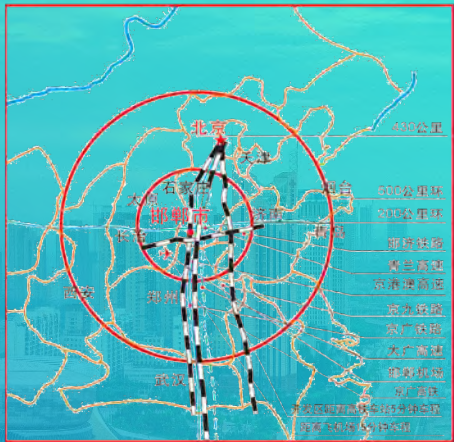

# 铁路

- 京广
- 邯长
- 邯济
- 邯黄铁路
- 京广高铁

# 高速

- 京港澳
- 青兰
- 大广
- 绕城
- 邯馆
- 太行山





## 邯郸到北京的高铁车程、到上海的航程均为2个小时

以邯郸为中心1小时经济圈，可覆盖中原经济协作区13个城市、6000多万人口、2.5万亿GDP。





# 邯郸

## 资源丰富、产业完备





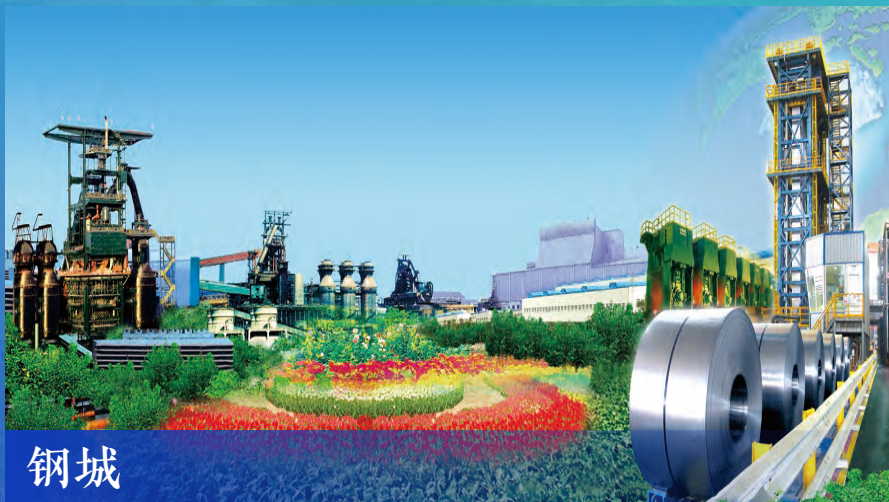

钢城



煤都



北方粮仓



冀南棉海

是国家重点建设的老工业基地



境内已  
发现矿  
产**29种**



煤炭  
53.8亿吨



铁矿石  
4.7亿吨

我国著名的焦动力煤和高品位铁矿石产区







邯郸是全国确定的小麦、棉花、玉米等5种主要农产品优势产区  
2021年全市粮食总产量**537万吨**





## 工业门类齐全



工业经济总量多年稳居河北省第二位



532

5

精品钢材

装备制造

食品加工

现代物流

文化旅游

3

新材料

新能源

生物健康

2

电子信息和网络

安防应急



HANDAN

# 精品钢材产业

FINE STEEL INDUSTRY





邯郸第一大主导产业，年产各类精品钢材3400多万吨，  
可以为各个用钢产业进行完整的产业链配套







# 邯钢公司

是河北省唯一汽车用钢实现“整车造”、家电用钢实现“全覆盖”的钢铁企业





邯钢老区退城整合

武安冀南钢铁

太行钢铁退城进园



# 2025

建成三千亿级的精品钢材生产基地  
实现钢铁大市向钢铁强市的跨越





HANIDANI

# 装备制造产业

MANUFACTURING EQUIPMENT INDUSTRY





## 我市第二大主导产业

涉及金属制品业、通用设备制造业、汽车制造业、仪器仪表制造业等8个大类

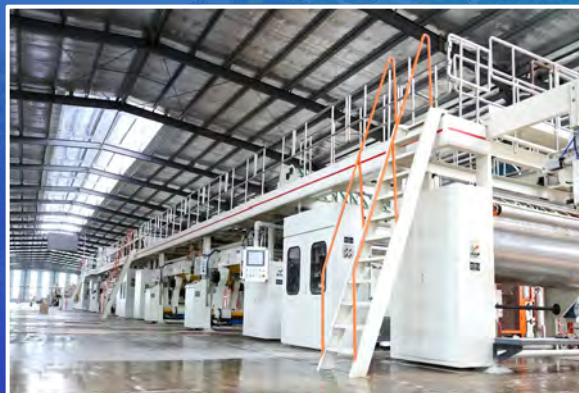





新兴铸管



汉光重工

## 知名企业

拥有新兴铸管、汉光重工、美的家电、  
格力精密装备制造等一批知名企业

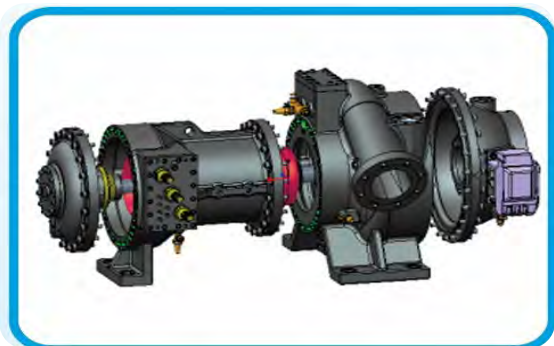

格力精密装备制造



美的家电



永年标准件占有全国45%的市场份额，位居全国第一位





2025

建成**两千亿级**的全国重要的先进装备  
制造基地





# 五得利面粉集团

面粉加工能力居全国首位





# 晨光生物科技集团

辣椒红色素、辣椒精、叶黄素产销量分别占全球市场的1/2、1/3、1/4





# 龙凤山铸业公司

是全球最专业的研制生产超高纯生铁、高纯生铁和亚共晶生铁的企业





# 中船汉光公司

墨粉产销量居全国第一





# 中船718所

是全国最大的水电解制氢和甲醇裂解制氢装置研发生产单位、国内燃料电池高压车载氢系统最大的供应商

中国船舶第七一八研究所





# 邯钢气体厂

是全国最齐全的稀有气体生产企业和高纯商品氢生产商





# 像这样的龙头企业、领军企业还有很多

这些产业和企业的发展，为邯郸经济发展注入了强劲动力，也使邯郸成为各类企业强链、延链、补链的优选之地。





# 邯鄲

## 山川壯麗、風景秀美





绚丽的民俗风情  
壮美的自然风光  
璀璨的历史文化

造就了  
邯郸美丽怡人的旅游胜境

Hebei  
京畿福地 乐享河北  
Enjoy Hebei

2021  
河北邯郸



# 世界文化遗产——大运河流经邯郸





# 全市拥有涉县娲皇宫、广府古城2处5A级景区







丛台公园



赵苑公园



冀晋鲁豫烈士陵园



涉县八路军一二九师司令部旧址



涉县太行五指山



涉县韩王九寨



武安朝阳沟



武安京娘湖



武安东山文化博艺园



武安长寿村



武安七步沟



武安东太行



峰峰响堂山石窟



馆陶粮画小镇



肥乡丛台酒苑



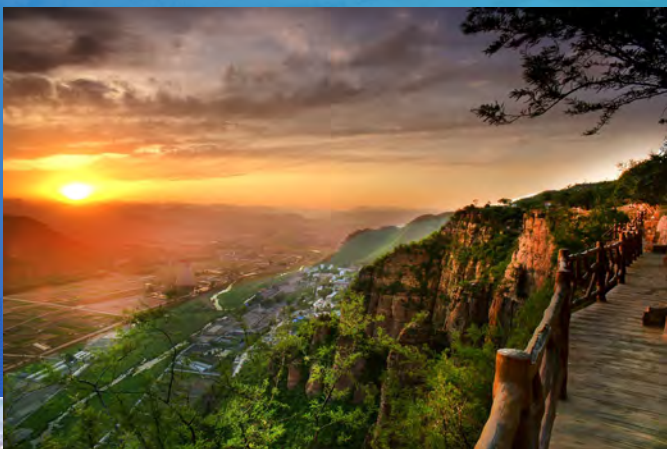

- 2处国家风景名胜区
- 2处国家森林公园
- 5处国家水利风景区





# 3处国家湿地公园

## 40处全国重点文物保护单位

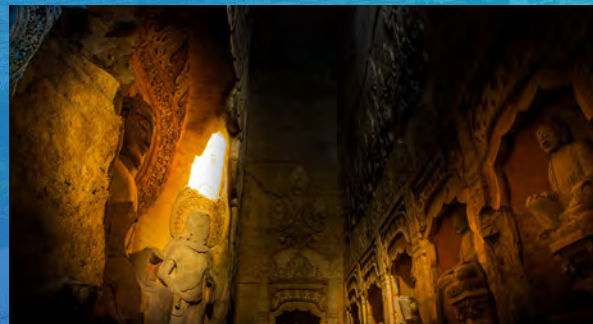



武安地质公园、青崖寨  
分别为国家地质公园、国家自然保护区





邯鄲

宜商宜业、环境优美





是最早推行行政权力公开透明运行的试点市  
拥有全国一流的政务服务中心





99%以上

“一网通办”率

最多跑一次

100个高频事项办理

1日办结

企业开办

中国营商环境质量十佳城市

中国最具海外影响力城市

中国金融生态城市

全国十佳开放型政府杰出服务奖

中国最具创新绩效城市



全市有国家级经济开发区1家





# 省级开发区20家

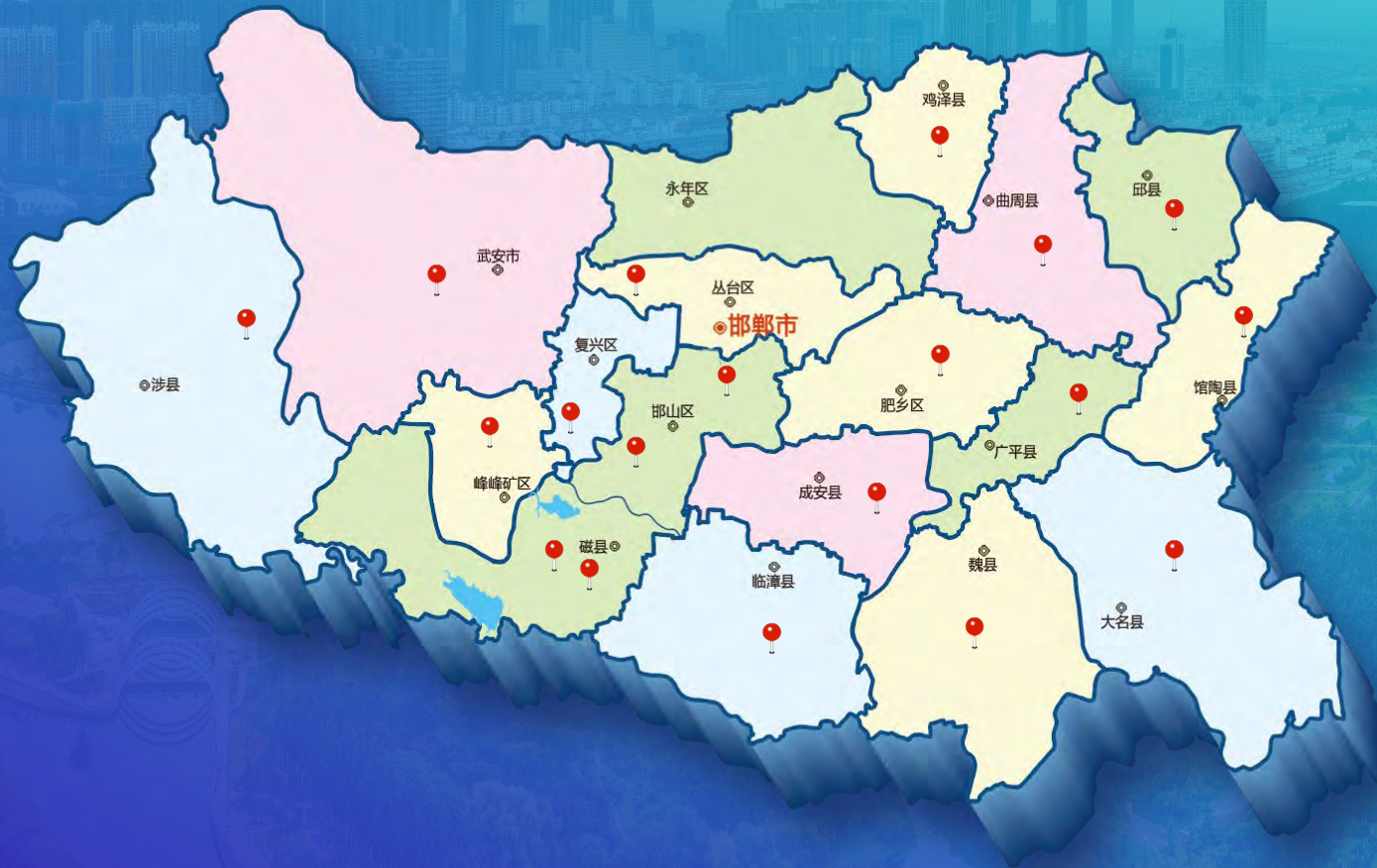



# 邯郸城市功能完善

- 推进东部东湖新城建设
- 联动南部滏阳新城
- 提升西部生态新城
- 培育北部产业新城
- 优化中部老城区

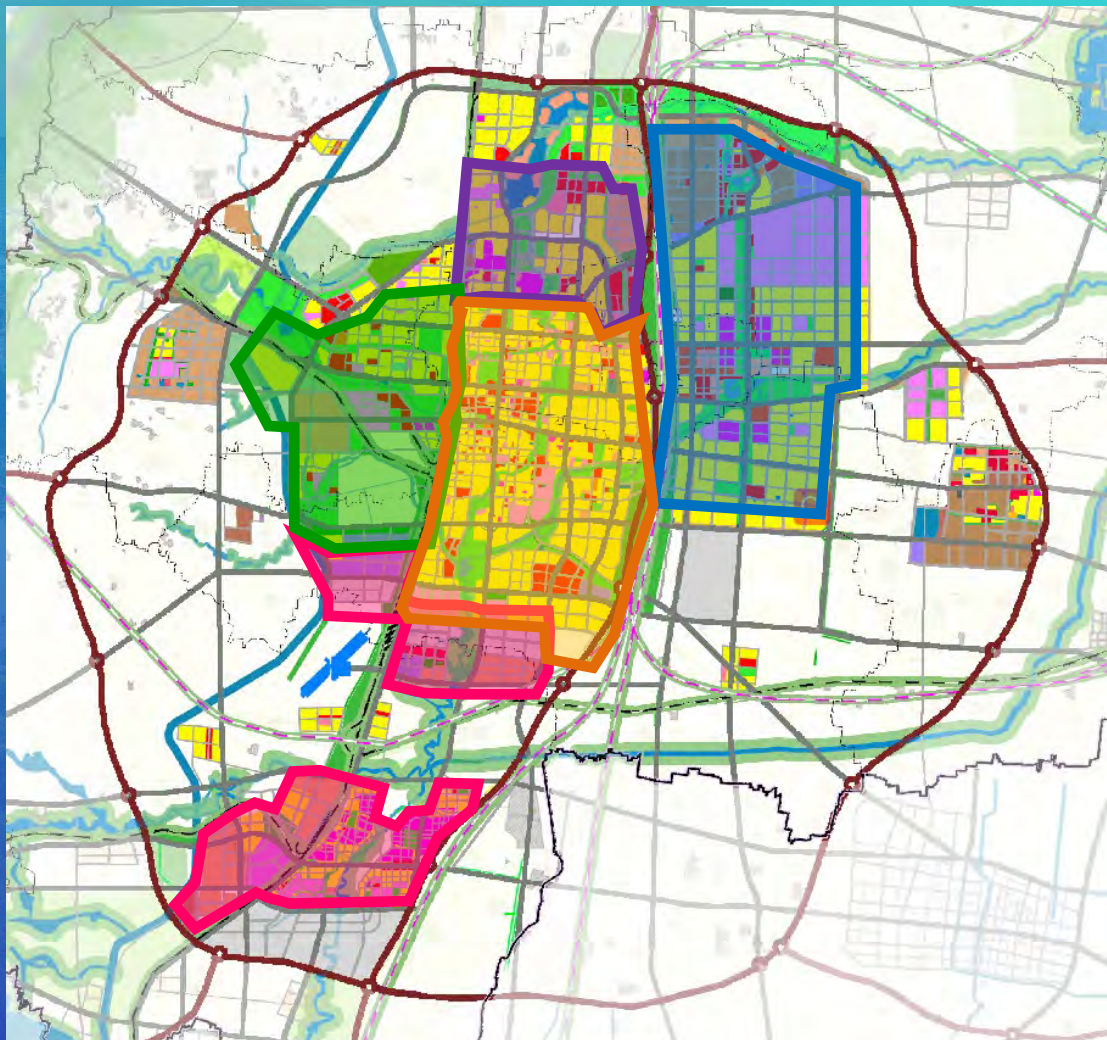



打造现代化都市圈，提升区域中心城市首位度，  
让来邯投资的客商发展顺心、生活舒心





邯郸这片投资热土  
孕育着发展希望 蕴含着合作商机





诚挚邀请海内外广大有识之士，  
来邯考察洽谈，拓展新的发展空间







走进邯郸、感悟邯郸、投资邯郸



施展才华的舞台  
成就事业的沃土  
温馨生活的家园





最优惠的政策 最优质的服务 最优越的环境





邯郸

武灵丛台

一座等了您三千年的城